



Installation and User's Guide

Models
ULT50-AM
ULT60-AM
ULT74-AM
ULT88-AM
ULT100-AM



We value your feedback!

Your input helps to create even better products and experiences.
Share the warmth and leave a review.

dimplex.com/sharethewarmth

 **YouTube** @DimplexNorthAmerica 



IMPORTANT SAFETY INFORMATION:

Read this manual first before attempting to install or use this electric fireplace. Always comply with the warnings and safety instructions contained in this manual to prevent personal injury or property damage.

To view the full line of Dimplex products, visit www.dimplex.com



INSTALLER: LEAVE THIS MANUAL WITH THE APPLIANCE.
CONSUMER: RETAIN THIS MANUAL FOR FUTURE REFERENCE

Table of Contents

Registration	3
⚠ IMPORTANT INSTRUCTIONS	4
Technical Specifications	6
Electrical Rating	6
UL Listing	6
Product Dimensions	6
Package Contents	7
Installation	8
Placement	8
Operation	18
Heater Operation	18
Flame Connect app	18
Onboard controls	19
Remote control	19
Maintenance	21
Troubleshooting	22
Wiring Diagrams	23
Warranty	25

Conventions used in this manual:



NOTE:

Procedures and techniques that are considered important enough to emphasize.



CAUTION:

Procedures and techniques which, if not carefully followed, will result in damage to the equipment.



WARNING:

Procedures and techniques which, if not carefully followed, will expose the user to the risk of fire, serious injury, or death.

Registration



REGISTER YOUR PRODUCT ONLINE

www.dimplex.com/register

Please record your model and serial numbers for future reference.

Model _____

Serial Number _____

Model and serial number label
+
QR Code label
(underneath the sill trim)

For more information on
the Flame Connect app,
visit

www.flame-connect.com

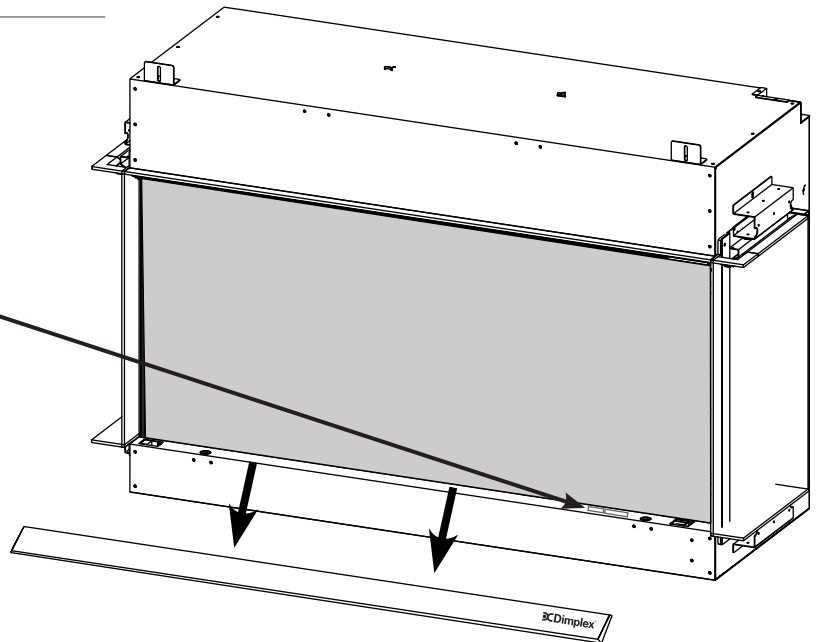

NO NEED TO RETURN TO THE STORE

If you have questions regarding the operation of this product or if you require service, before returning this product to the place of purchase.

For technical support, contact us at:



www.dimplex.com/support

or



Toll-Free 1-888-346-7539

Please have your model number and product serial number ready.

SAVE THESE INSTRUCTIONS

IMPORTANT INSTRUCTIONS



WARNING: Read all instructions and warnings carefully before starting installation. Failure to follow these instructions may result in a possible electric shock, fire hazard and will void the warranty.

When using any electrical appliance, basic precautions should always be followed to reduce the risk of fire, electric shock, and injury to persons. These precautions include:

- ① Read all instructions before using this electric fireplace.



WARNING: High temperatures may be generated under certain abnormal conditions. Do not partially or fully cover or obstruct the front of the fireplace.

- ② This fireplace is hot when in use. To avoid burns, do not let bare skin touch hot surfaces. The trim around the heater outlet becomes hot during heater operation. Keep combustible materials, such as furniture, pillows, bedding, papers, clothes, and curtains at least 3 feet (0.9 m) from the front of the fireplace.
- ③ Extreme caution is necessary when the fireplace is used by or near children or people with disabilities and whenever the fireplace is left operating and unattended.
- ④ Always turn off the fireplace when it is not in use.
- ⑤ Do not operate the fireplace after it malfunctions, has been dropped, or damaged in any manner. Disconnect power at the service panel and have the fireplace inspected by a reputable electrician before using.
- ⑥ Do not use this fireplace outdoors.
- ⑦ Never locate the fireplace where it may fall into a bathtub or other water container.
- ⑧ Do not insert or allow foreign objects to enter any ventilation or exhaust opening as this may cause an electric shock, fire, or damage to the fireplace.
- ⑨ To prevent a possible fire, do not block air intakes or exhaust in any manner.
- ⑩ To disconnect the heater, turn the unit off with the controls and turn off the power to the heater circuit at the main disconnect panel.
- ⑪ All electrical heaters have hot and arcing or sparking parts inside. Do not use it in areas where gasoline, paint, or flammable liquids are used or stored.
- ⑫ Do not modify this fireplace. Use it only as described in this manual. Any other use may cause fire, electric shock, or injury to persons.
- ⑬ Do not burn wood or other materials in this fireplace.
- ⑭ Disconnect all power coming to the fireplace at the main service panel before performing any cleaning or maintenance.
- ⑮ When transporting or storing the fireplace, keep it in a dry place, free from excessive vibration, and store to avoid damage.
- ⑯ Always use a qualified technician or service agency to repair this fireplace.



NOTE: Changes or modifications not expressly approved by the party responsible for compliance could void user's authority to operate the equipment.



CAUTION
RISK OF ELECTRIC SHOCK
DO NOT OPEN
NO USER-SERVICEABLE PARTS INSIDE



IMPORTANT INSTRUCTIONS

FCC Compliance

⚠ CAUTION: This unit has been tested and found to comply with the limits for Class B digital device, pursuant to part 15 of the FCC Rules. These limits are designed to provide reasonable protection against harmful interference in a residential installation. This unit generates, uses and can radiate radio frequency energy and, if not installed and used in accordance with the instructions, may cause harmful interference to radio or television reception, which can be determined by turning the unit OFF and ON, the user is encouraged to try to correct the interference by one or more of the following measures:

- Reorient or relocate the receiving antenna.
- Increase the separation between the unit and the receiver.
- Connect the unit into an outlet on a circuit different from that to which the receiver is connected.
- Consult the dealer or an experienced radio/TV technician for help.

This unit complies with Part 15 of the FCC Rules. Operation is subject to the following two conditions:

(1) This unit may not cause harmful interference, and (2) this unit must accept any interference received, including interference that may cause undesired operation.

⚠ FCC CAUTION: Any changes or modifications not expressly approved by the party responsible for compliance could void the user's authority to operate this equipment.

⚠ WARNING: This product can expose you to chemicals including nickel which is known to the State of California to cause cancer. For more information, visit www.P65Warnings.ca.gov

Technical Specifications

Electrical Rating

Voltage: 120 V (3-Wire) or 240 V (4-Wire)

Power: 1500 W at 120 V, 2500 W at 240 V

UL Listing

File Number: E71416

Model	SKU	UL Number
ULT50-AM	500003149	6914190200
ULT60-AM	500003151	6914190700
ULT74-AM	500003152	6914190800
ULT88-AM	500003154	6914190900
ULT100-AM	500003155	6914191000





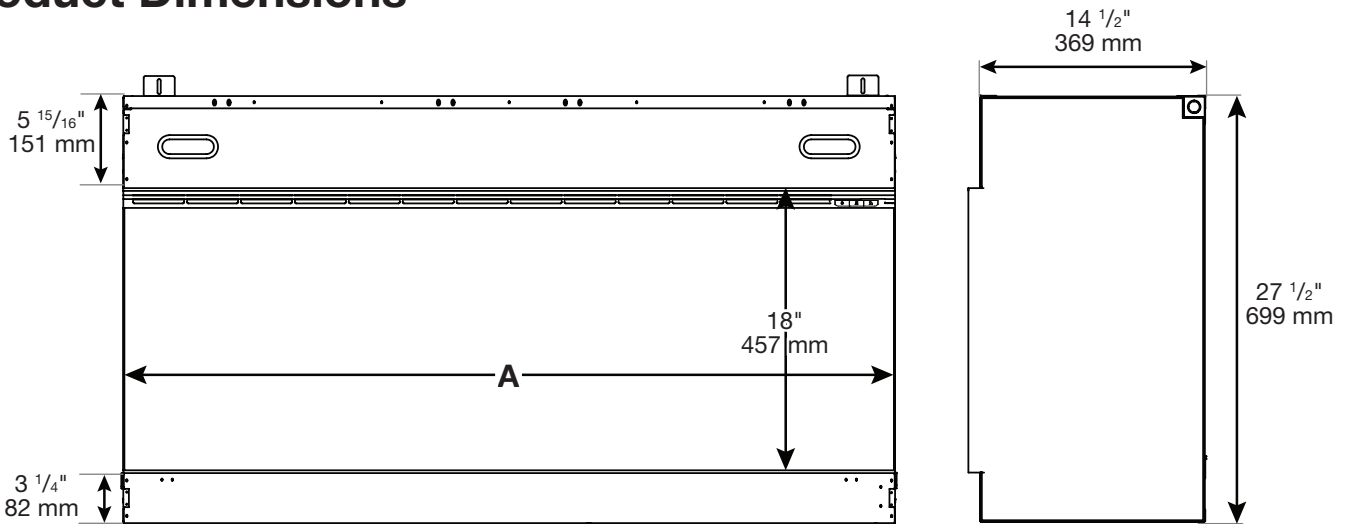



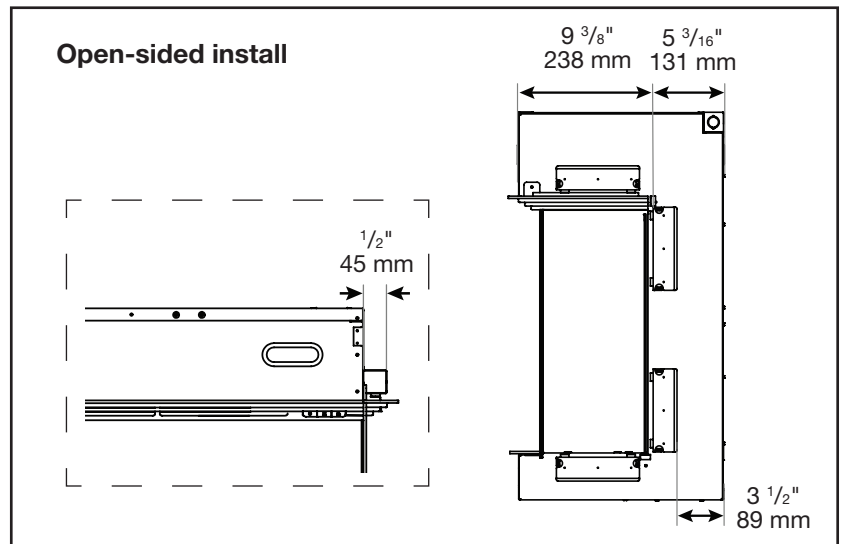



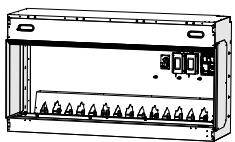

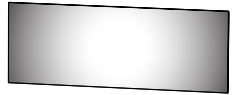
Product Dimensions

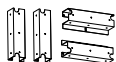

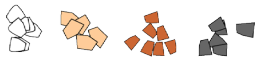



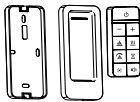
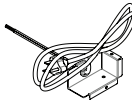
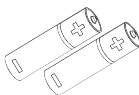

Model	A	
ULT50-AM	$50 \frac{9}{16}$ "	1285 mm
ULT60-AM	$60 \frac{9}{16}$ "	1539 mm
ULT74-AM	$74 \frac{9}{16}$ "	1895 mm
ULT88-AM	$88 \frac{9}{16}$ "	2250 mm
ULT100-AM	$100 \frac{9}{16}$ "	2555 mm

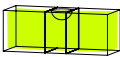
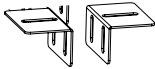

Package Contents

Image	Description	Qty	Image	Description	Qty
	Firebox	1		Reflective glass bracket	1
	Reflective glass	1		Sill trim	1
	Front glass	1		Open side brackets	8 pieces
	Side glass	2		Open side trim	6 pieces
	Tumbled glass embers	Varies		Suction cups	2
	Gravel	Varies		Top grill	1
	Glass chunks	Varies		User's and Installation Guide	1
	Logs	ULT50: 6 ULT60: 9 ULT74: 11 ULT88: 12 ULT100: 14		Remote control with wall mount	1
	Plug kit	1		AAA batteries	2

Hardware Kit

Image	Description	Qty	Image	Description	Qty
	1/2" black screws	12		Bubble level	1
	Mounting brackets	2		Linking brackets	2
	1" wood screws	2		Drywall anchor	4
	Wire connectors	4		1 1/4" screws	4

*Package contents are subject to change

Installation

Placement

Installation Height

It is recommended that the bottom of the unit be mounted a maximum of 40" (102 cm) from the ground to maintain an optimized viewing angle of the flame.

⚠ WARNING: The top of the fireplace must be installed a minimum of 24" (61 cm) from the ceiling.

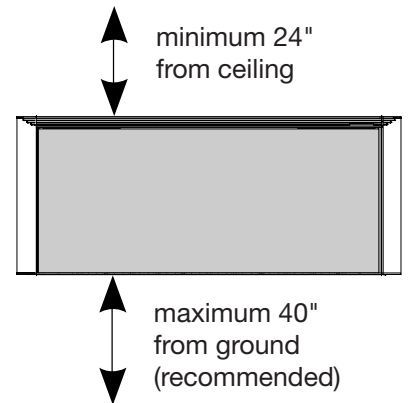

Installation in a Bathroom

If this unit is installed in a bathroom, it must be protected by a GFCI receptacle or circuit. If a receptacle is used, it must be readily accessible.

This electrical appliance is NOT watertight. To prevent electric shock, it must be installed as to prevent water from entering unit, or installed away from showers, tubs, etc. Never locate fireplace where it may fall into a bathtub or other water container.



Wi-Fi

For installations where the use of the Flame Connect app is desired, ensure the fireplace is located within range of a Wi-Fi network.



Installation of Overhanging Objects

For overhanging temperature-sensitive objects, such as a television, a mantel, or artwork, always follow the recommendations provided by its manufacturer for installation over a heater.

! NOTE: Using normal heat mode, surfaces 10" (25 cm) above the fireplace will not exceed 40° C, as long as installation procedures are followed and heater inlet and outlet are not obstructed.

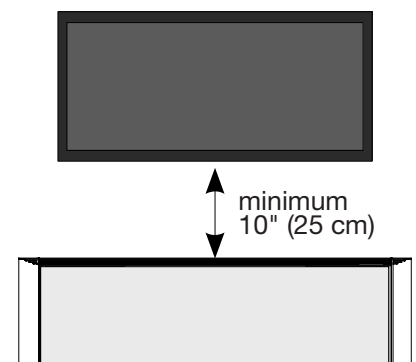

Installation



! NOTE: Two or more people are required for installation. Use the handles located at the top on both sides of the fireplace to maneuver the unit.

1 Build framing

Framing Dimensions

Model	Width	Height	Depth
	A	B	C
ULT50-AM	50 3/4" 1290 mm	28" 712 mm	15" 382 mm
ULT60-AM	60 3/4" 1544 mm		
ULT74-AM	74 3/4" 1899 mm		
ULT88-AM	88 3/4" 2255 mm		
ULT100-AM	100 3/4" 2560 mm		

Prepare a wall with a framed opening, following the dimensions in the table.

For linked installation, add widths of fireplaces used.

! CAUTION: This fireplace is **NOT** load-bearing. Ensure the opening for the fireplace is framed in such a way that the weight of the building materials will not create pressure on the top of the fireplace.

! NOTE: Wiring connections are located at the back of the firebox, in the top right corner.

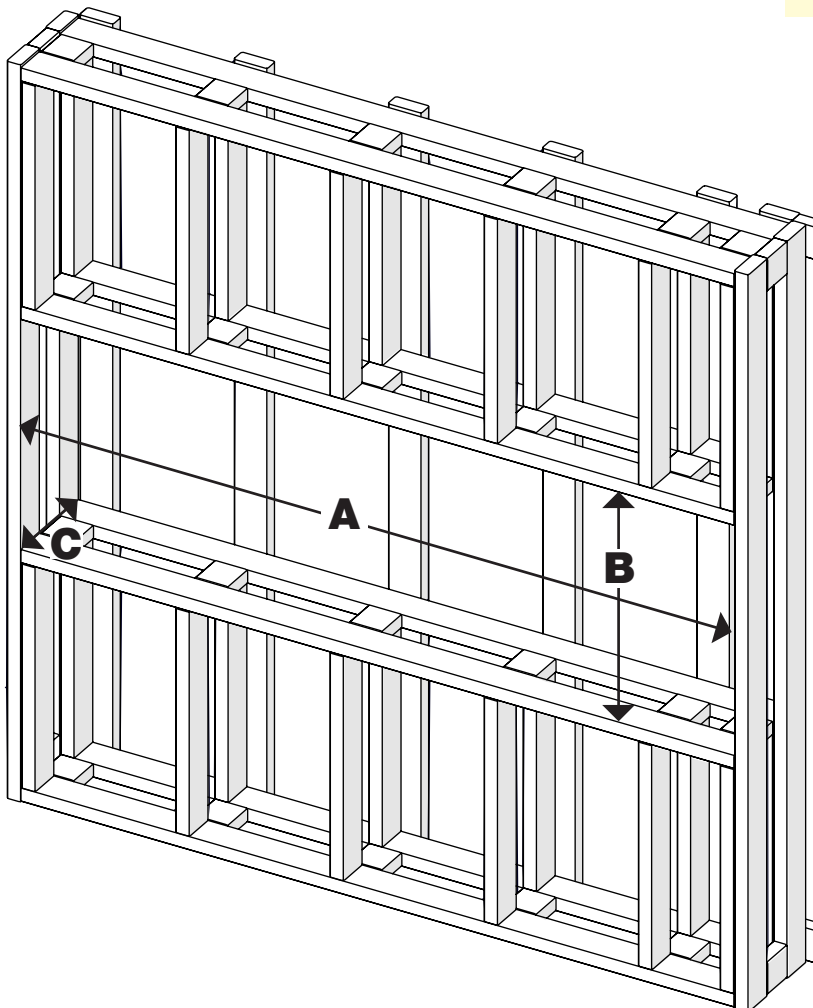

Open-sided install	
D	E
3 1/2" 90 mm	1" 25 mm

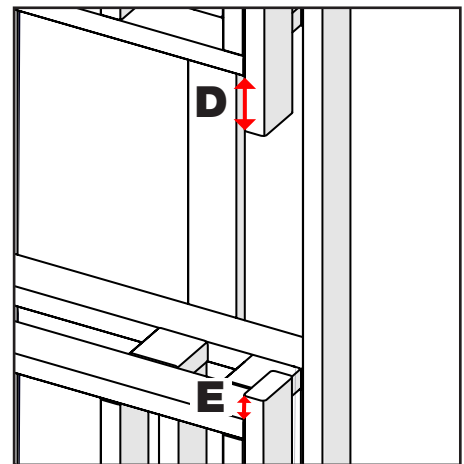

Alternate view for open-sided installation

Installation

2 Optional step: remove the side panels (**ONLY** for open-sided and linked installation)

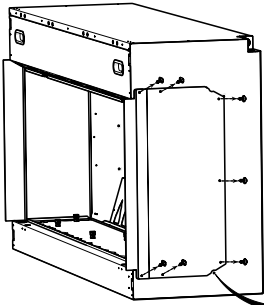

1. Remove the side panel(s) on the side(s) that will be open or adjoining.
2. For linked installation: Remove screw on sides that will be connected.

Linked installation only

3 Install mounting brackets

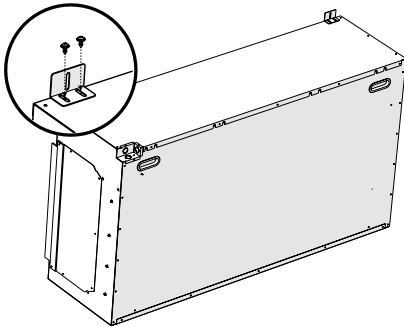
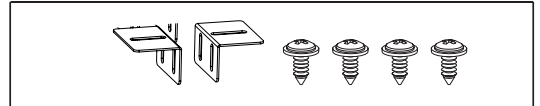

Install the mounting brackets to the top of the firebox with the black screws provided.

Installation

4 Connect power supply

⚠ WARNING: Use the appropriate wire to meet local and national electrical codes for rated power consumption.

⚠ WARNING: The installation of the electric fireplace must comply with the applicable Local and/or National Electrical Codes and utility requirements.

⚠ WARNING: This heater is not intended for use with an extension cord. Plug the cord directly into an appropriate grounded wall receptacle.

⚠ CAUTION: A dedicated, properly fused 15 Amp circuit is recommended, rated for the appropriate voltage (120 V, 240 V). A dedicated circuit will be required if, after installation, the circuit breaker trips or fuse blows on a regular basis when the heater is operating. Additional appliances on the same circuit may exceed the current rating of the circuit breaker.

⚠ WARNING: The power cord option is only suitable for 120 V installations.

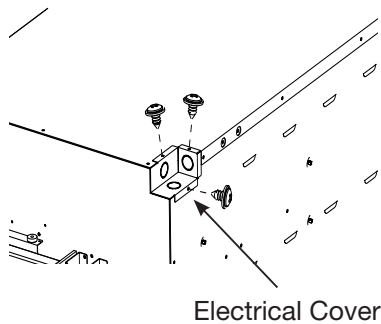

1. Remove the screws that secure the electrical cover.
 - If using the power cord, proceed to step 4, following the diagram for 120 V wiring.
2. Knock out the section of the wiring cover that is most suitable for your installation. Three knock-out options are provided.
3. Secure a 1/2" (1.3 cm) approved strain relief on the electrical cover and route the wires through it.
4. Complete the wiring according to the chosen installation. Ensure all wire connections are tight.
5. Secure the electrical cover.

120 V Installation (hardwired or power cord)

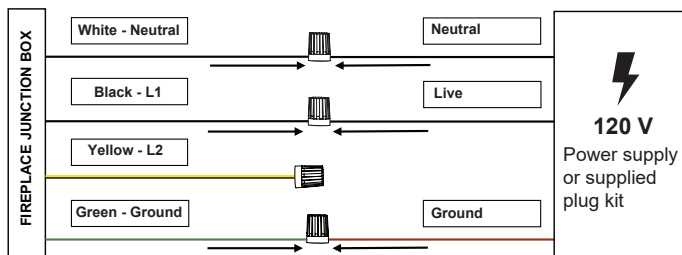

240 V Installation (hardwired only)

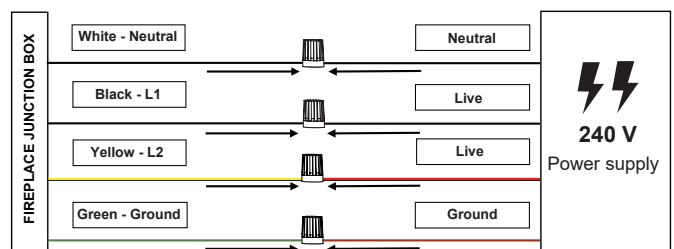

! NOTE: The fireplace is supplied with the power switch in the OFF position. It is located in the lower right side.



Installation

5 Place the firebox in the framing and level it

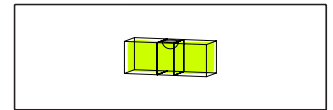
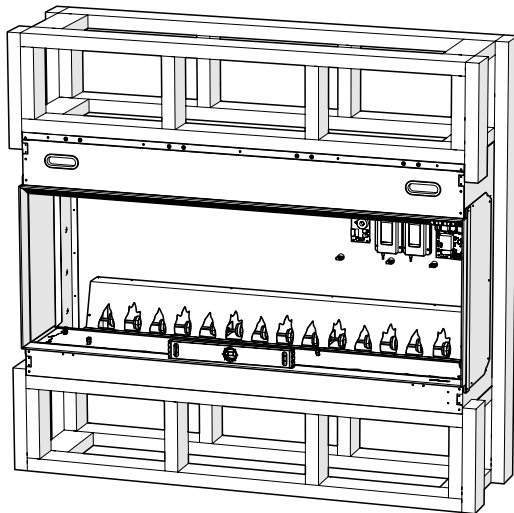

1. Lift the firebox into the opening in the frame using the handles on the back and sides of the fireplace.
2. Using the bubble level, ensure the firebox is level, adjusting as necessary.

6 Secure mounting brackets

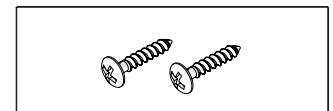
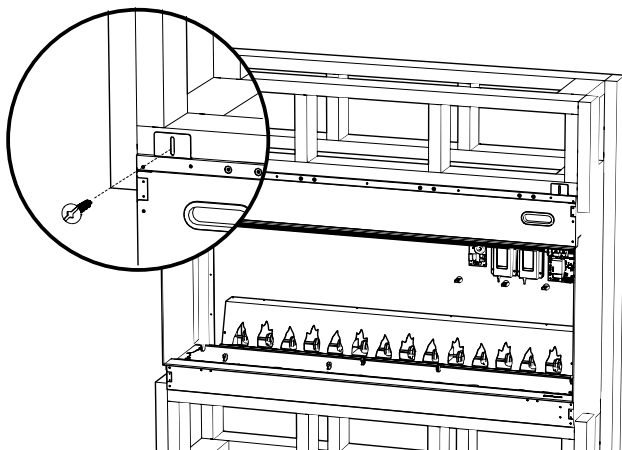

Secure the mounting brackets at the top of the fireplace to the framing with the provided wood screws.

! NOTE: The mounting brackets are equipped with slots to allow small adjustments to fit the framing. Ensure both brackets are aligned.

7 Optional step: install the linking brackets (ONLY for linked installation)

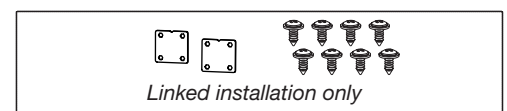
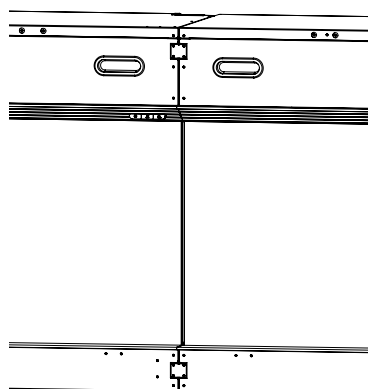

Install the linking brackets to connect adjoining fireplaces.

Installation

8 Optional step: disconnect the heater (ONLY for installation with no heat)

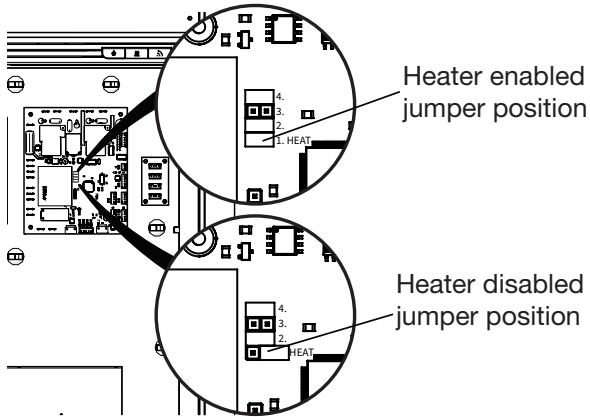

! NOTE: This option is not recommended for seasonal heat disabling. Temporary disabling of the heater can be achieved through the onboard control; see “Heat Disable” in *Operation* table for instructions.

Follow these instructions **only** when an installation without heat is required.

1. Locate the driver board. The heater hardware disconnect jumper location is labeled “1. HEAT”.
2. Pull out the heater hardware disconnect jumper. Place it only on one of the pins, as shown.

9 Install the mirrored glass

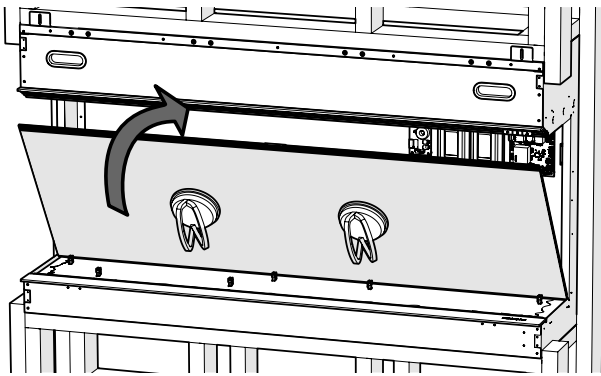
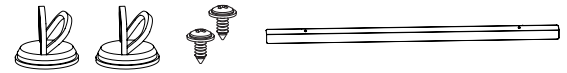

! CAUTION: The magnet at the top will hold the glass in place to facilitate installation. It is necessary to install the bracket to ensure the glass does not fall.

1. Secure the suction cup to the reflective side of the mirrored glass (black edge goes at the top).
2. Lift the mirrored glass and place it into the bottom slot at an angle, then tilt the mirrored glass into a vertical position.
3. Align the bracket to two screw holes and secure with screws.

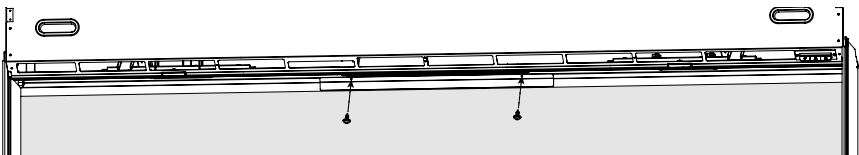

Installation

9 Install the side glass

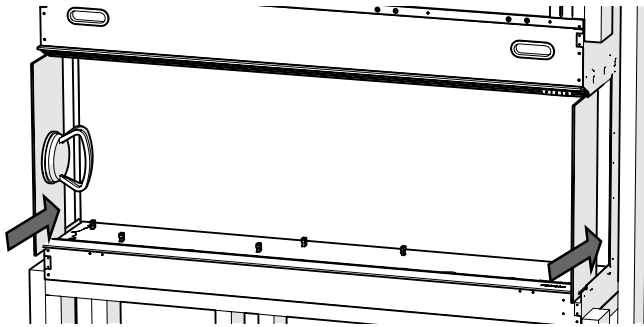
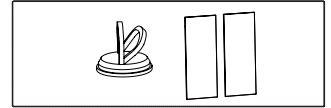

! NOTE: The side glass should be installed even on closed-sided installations.

1. Secure the suction cup to the side glass to prevent fingerprints on the outside of the glass.
2. Slide the glass in from the front. Once it is in place it will drop to its final position.
3. Clean the glass with a damp cloth and dry it with a lint free dry cloth. Ensure there are no debris or finger prints on the mirrored glass, inner sides of the side glass, or on the inner side of the front glass before you begin

10 Place tumbled glass and gravel

For best results when using the supplied glass media, arrange as follows:

1. Pour the white frosted glass on the ember bed closest to the mirrored glass.
2. Pour the amber frosted glass around the edge of the white frosted glass.
3. Pour the dark amber around the edge of the light amber frosted glass.
4. Pour the black frosted glass around the edge of the dark amber frosted glass.
5. Sprinkle the black and grey gravel over the glass media.

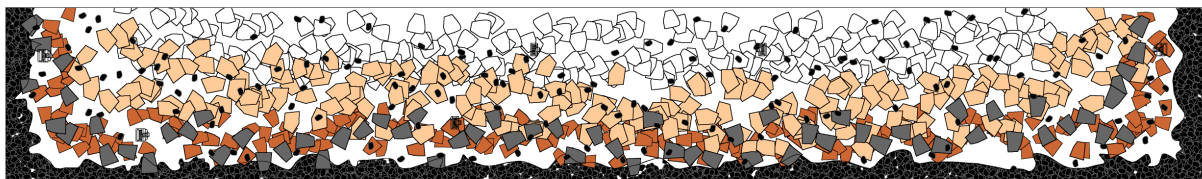

! NOTE: It is possible to use custom media ornaments to decorate your firebox. The custom media must fit easily without scratching the glass or bowing the ember bed, and must not be composed of liquid, which could interfere with the safety of the firebox.

If removing any logs in the arrangement, the corresponding wire will need to be removed from the log expansion board, located under the ember bed. Each remaining wire must be plugged sequentially in the log expansion board, beginning with the J1 position.

Installation

11 Place the logs

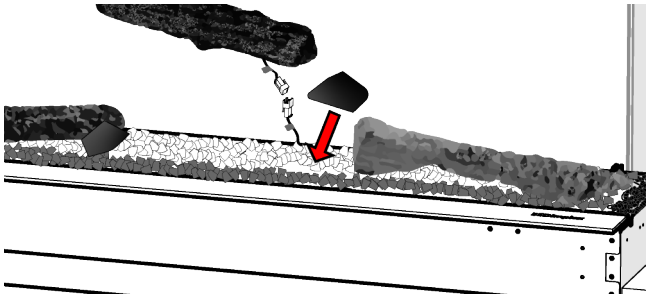

1. Connect the log to the connector with the corresponding label number, and place it as shown below.

! NOTE: Even-numbered logs should be placed first, followed by odd-numbered logs.

2. Place the large glass chunks to conceal the connectors.

Recommended log layout

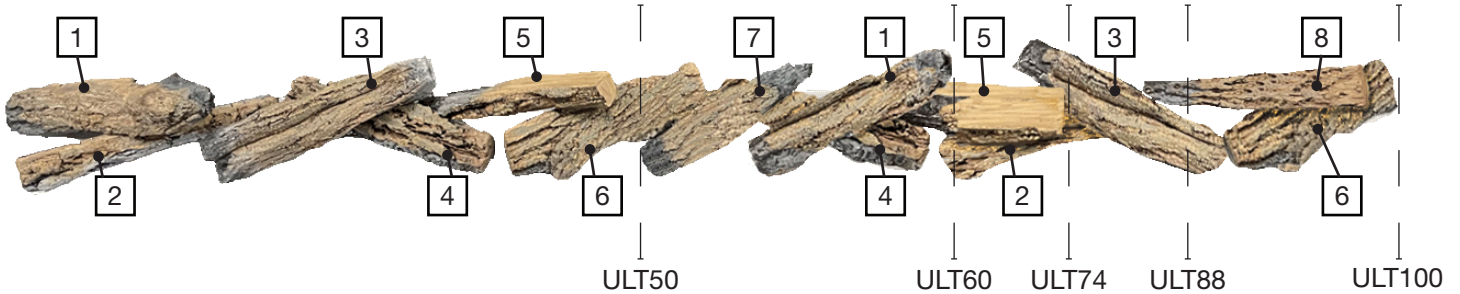

12 Install the front glass and top grille

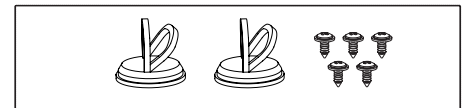
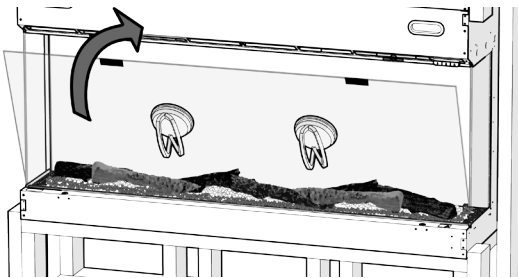

1. Ensure the suction cup is securely attached to the outer side of the front glass.
2. Using the suction cup to assist, gently place the front glass into the bottom slot at an angle, and tilt the glass into a vertical position.
3. Secure the top grille with the five provided screws.

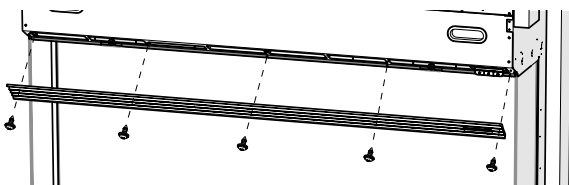

! CAUTION: The magnets at the top will hold the glass in place to facilitate installation. It is necessary to install the grille to ensure the glass does not fall.

13 Install the sill trim

! NOTE: Magnets are used to secure the trim pieces.

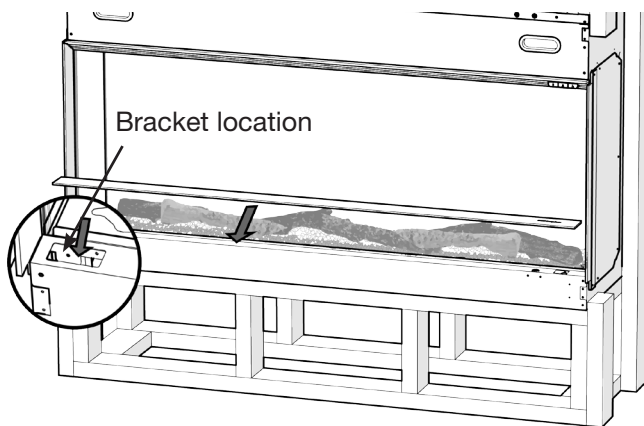
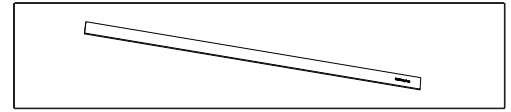

Place the Dimplex sill trim on the bottom lip of the fireplace, ensuring the bracket on the trim is aligned to the left.

14

Optional step: install side brackets and trims (ONLY for open-sided installation)

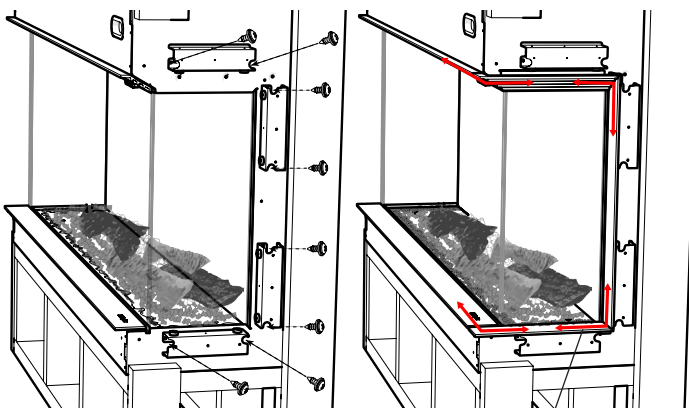

Align all trim pieces

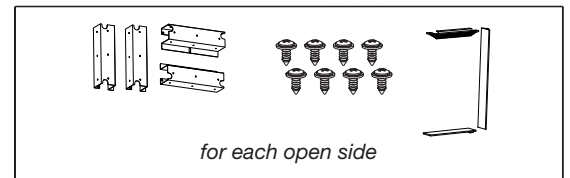

For bay or corner installations, install the side trim on each open side.

1. Loosely install the four trim brackets on each side using the screws provided.
2. Before fastening the screws entirely, connect the magnetic trim pieces and align them to the top grille and bottom sill.
3. Continue fastening the screws until all the trims are aligned.

Installation

15 Finish installation

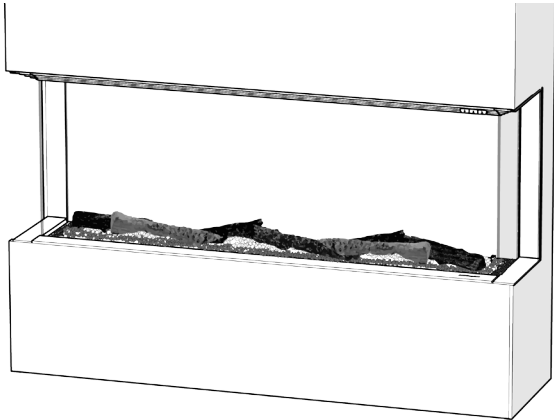

Finish the installation using the finishing materials of your choice.

⚠ CAUTION: Do not drill into firebox housing.

! NOTE: The fireplace trim is designed to be installed with 1/2" drywall or cement board. Other finishing materials can be used.

16 Optional step: Install the wall mount for remote control

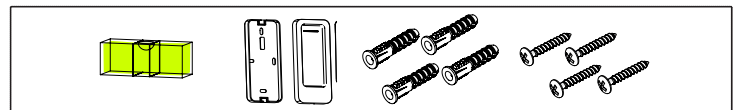
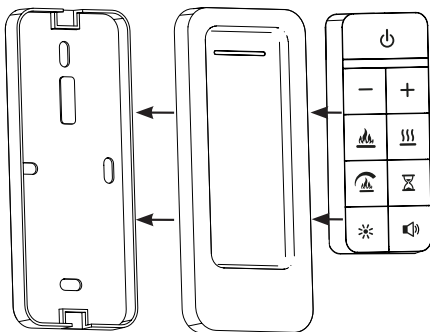

⚠ CAUTION: Check for pipes and cables behind the wall before drilling into the wall.

1. Place the wall mount in the desired location. Use a bubble level to ensure it is level. Mark the location of the holes.
2. Secure the wall mount using the anchors and screws, as required.
3. Snap on the cover to the wall mount.
4. Place the remote in the wall mount.

Operation

⚠ WARNING: This electric firebox must be properly installed before it is used.

! NOTE: The fireplace will retain the previously used settings after a power interruption.

Heater Operation

This firebox operates with ComfortSaver™ technology, which automatically adjusts the fan speed and heater wattage to safely and precisely match the requirements of the room based on the thermostat setting. If the temperature in the room rises significantly, the heater will turn off and periodically turn back on to circulate the air around the unit, until the room temperature drops and requires the heater to be on again.



! NOTE: The element retains heat after shutdown. When the heat is turned off, there is a 20-minute cool down period before the fan shuts off completely.

Resetting the Temperature Cutoff Switch

Should the heater overheat, a manual limit cut-out will turn the unit off and it will not come back on without being reset. It can be reset by turning the unit off at the main power switch and waiting 30 minutes before turning the unit back on.



⚠ CAUTION: If you need to continuously reset the heater, turn the unit off at the main disconnect panel and contact technical support.

Flame Connect app



Download the **Flame Connect app** on your mobile device and create an account. With the app you can add an extra level of personalization, such as saving customized mood settings.

For additional information, visit www.flame-connect.com



To add the fireplace to the Flame Connect app:

1. Press and hold  on the onboard controls for 10 seconds until it flashes blue.
2. Follow the instructions in the app to complete the installation.

Onboard controls

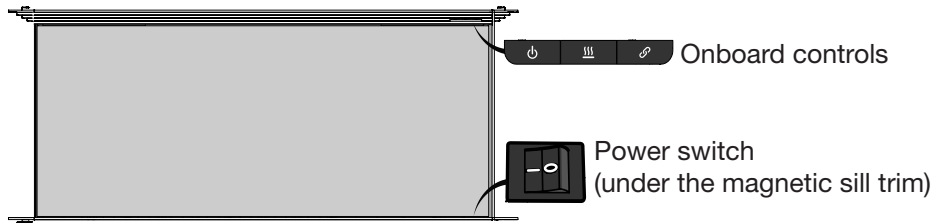



Remote control

The fireplace is supplied with a multifunction Bluetooth remote.













To synchronize the remote control:

In case of lost connection or remote control replacement, follow these steps to synchronize the remote control to the fireplace:

1. Remove the battery cover on the remote control using a Philips screwdriver to access the  button.
2. Press and hold  on the **onboard controls** for five seconds and, within ten seconds, press  on the remote.

!NOTE: One remote can control multiple units. Repeat the steps above with each fireplace to sync the remote.

To link multiple units together:

On the primary fireplace, press , , , , , . Within 20 seconds, press , , , , ,  on the secondary fireplace. This must be done using the **onboard controls**.

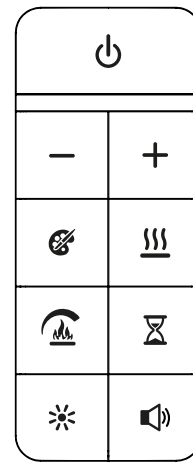

Operation

	Standby	<p>Press to turn on the unit or to put it in standby mode.</p> <p>When the unit is turned back on, it will retain the previously used settings.</p>
	Flame Effect	<p>Press to turn the flame theme and ember bed on or off. Press + or - to cycle through the different flame theme settings, indicated by LEDs on the remote control.</p> <p>Theme 1: Amber, yellow, and orange flame Theme 2: Yellow flame Theme 3: Amber flame Theme 4: Orange flame Theme 5: Amber and yellow flame Theme 6: Yellow and orange flame Theme 7: Midnight mode - flames on; embers and logs off Theme 8: Dusk mode - flames off; embers and logs on Theme 9: Custom - set using the Flame Connect app.</p>
	Heat	<p>Press to turn the heat on or off. Press + or - to cycle through the heat settings, indicated by LEDs on the remote control. The will remain lit on the fireplace while the heat is on.</p> <p>Blue LED: Fan only Green LED: Eco mode (18°C/64°F, low fan speed) Level 1: 18°C/64°F Level 2: 20°C/68°F Level 3: 22°C/72°F Level 4: 24°C/75°F Level 5: 26°C/78°F Red LED: Heat boost (max heat for 20 minutes before returning to level 5) White LEDs 1 & 8: Custom schedule - set using the Flame Connect app.</p> <p>The set temperature is only displayed on the Flame Connect app.</p> <p>The fireplace can be operated in heat only mode by turning off the flame.</p>
	Heat Disable	<p>Press and hold on the onboard controls for 10 seconds to disable or enable the heat function.</p> <p>When the heat is disabled and the is pressed, the icon will flash three times.</p>
	Flame Speed	<p>Press to adjust the flame speed using + or - to cycle through the settings.</p>
	Timer	<p>When this function is active, the fireplace will turn off after a set amount of time. The timer can be set from 1 hour to 8 hours.</p> <p>Press to activate the timer. Press the + or - to cycle through the intervals. To turn the timer off, press twice.</p> <p>While the timer is active, press to see the time remaining. The position of the lit LED on the remote represents the number of hours remaining.</p>
	Brightness	<p>Press to turn the overhead lights on or off. Press + or - to adjust the brightness of the flame, logs, ember bed, and overhead lights.</p>
	Flame Sound	<p>Press to turn the flame sound effect on or off. Press + or - to adjust the volume.</p> <p>More flame sounds are available through the Flame Connect App.</p>
	Factory reset	<p>Press , , , , , in sequence on the onboard controls to reset all the settings to factory default. This action will also disconnect the unit from the Wi-Fi network and the remote control will have to be resynchronized to the unit.</p>

Maintenance

Remote control battery replacement

To replace the battery:

1. Remove the battery cover on the remote control using a Philips screwdriver.
2. Install two AAA batteries in the battery holder.
3. Secure the battery cover.



Battery must be recycled or disposed of properly. Check with your Local Authority or Retailer for recycling advice in your area.

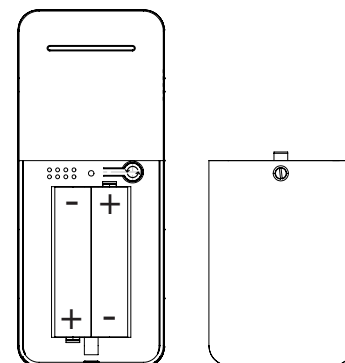

⚠ WARNING: Disconnect power and allow heater to cool before attempting any maintenance or cleaning to reduce the risk of fire, electric shock or damage to persons.

Fireplace surface cleaning

Use only a damp cloth to clean painted surfaces of the fireplace. Do not use abrasive cleaners.

The fireplace should not be operated with an accumulation of dust or dirt on or in the unit, as this can cause a build-up of heat and eventual damage. For this reason the heater must be inspected regularly, depending upon conditions and at a minimum yearly intervals.







Servicing

Except for installation and cleaning described in this manual, an authorized service representative should perform any other servicing.

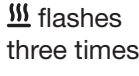

Troubleshooting

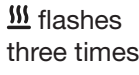
For more troubleshooting, consult the service manual which can be found at www.dimplex.com/customer_support/technical_and_troubleshooting

Problem	Display	Cause	Solution
Some gravel detached from media bed	N/A	Normal occurrence	It is normal for some gravel to become detached from the ember bed during transit.
Fireplace does not turn on with the manual touch controls	N/A	Power switch in off position	Ensure the rocker switch is in the ON position. Ensure wall switch is on (if applicable).
		No incoming power	Ensure unit is wired correctly. Check main disconnect panel.
Fireplace does not turn on with the remote control	N/A	The remote is not synced to the fireplace	Ensure the remote is synced to the fireplace. Reference the operation section for instructions.
		The batteries in the remote control are dead or installed incorrectly	Replace remote control battery
Heater does not turn on	 flashes three times	Heater is disabled	Press and hold  on the fireplace for 10 seconds to disable or enable the heat function.
	 flashes three times	Heater has been hardware disabled	If installation with heat is desired, reinstall jumper on the main board if available or replace it with a new main board or jumper.
Heater is on, but there is no heat	N/A	Temperature not set high enough	See operation section for instruction on changing set temperature.
Circuit breaker trips or fuse blows when unit is turned on	N/A	Improper circuit current rating	Install unit on a dedicated minimum 15 amp circuit.
Error Code is displayed (On the Flame Connect App only) 	Err 1	Temperature cut-out is activated	Reset breaker and wait 5 minutes before turning unit back on it. If error persists, see Service Manual.
	Err 12	Ambient temperature is above 45° C (113° F)	No action required.
	Err 13	Ambient temperature is below 5° C (41° F)	No action required.
	Err 16	NTC not detected	See service manual.

Wiring Diagrams

ULT50-AM

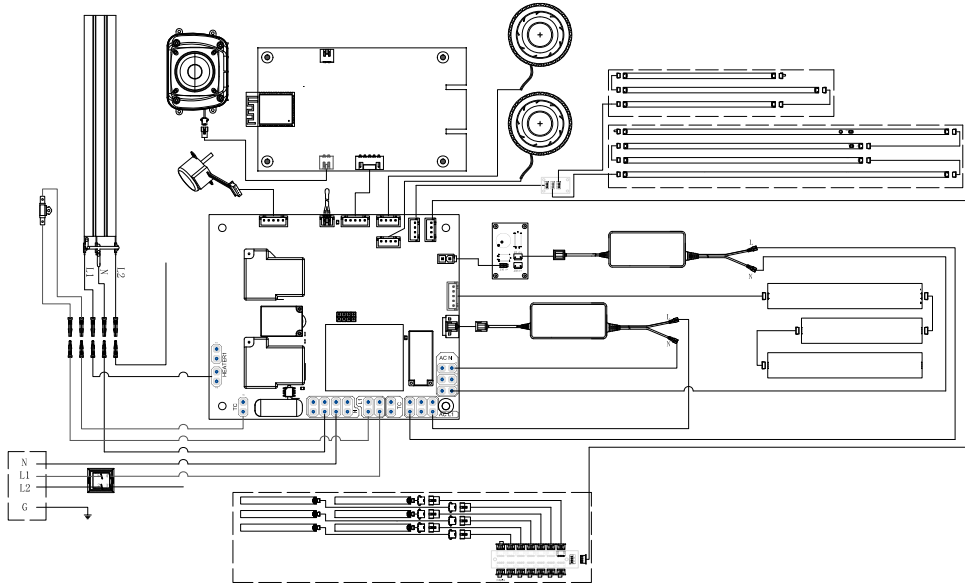

ULT60-AM

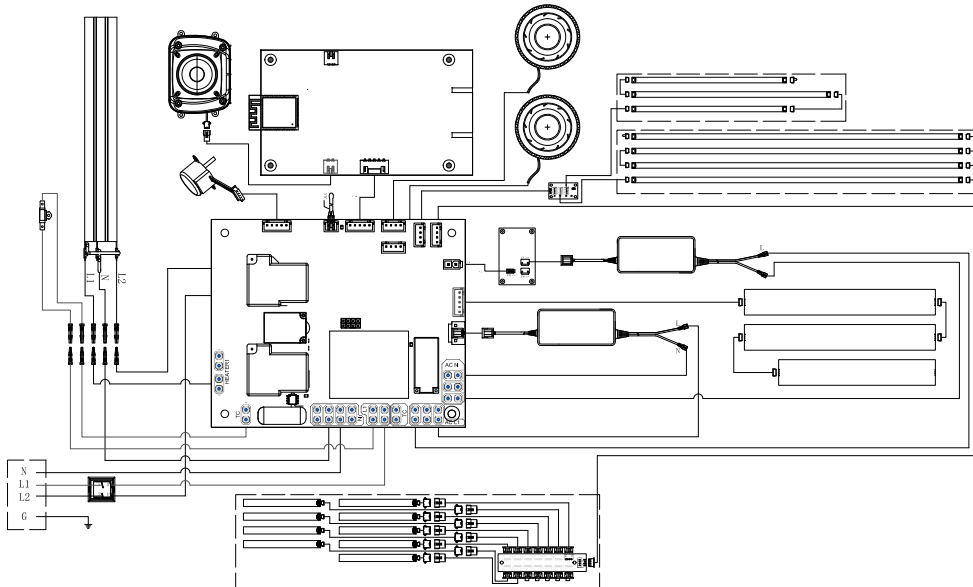

ULT74-AM

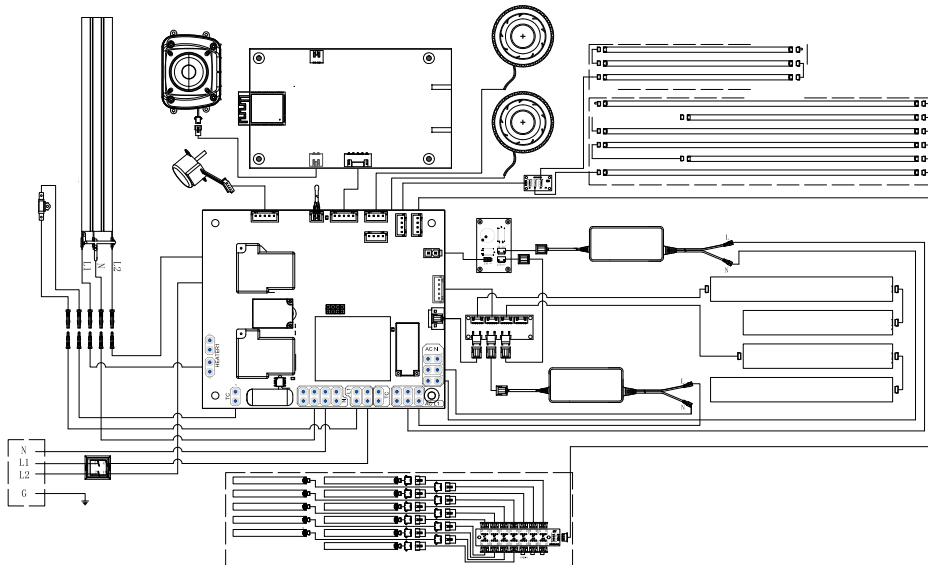

Wiring Diagrams

ULT88-AM

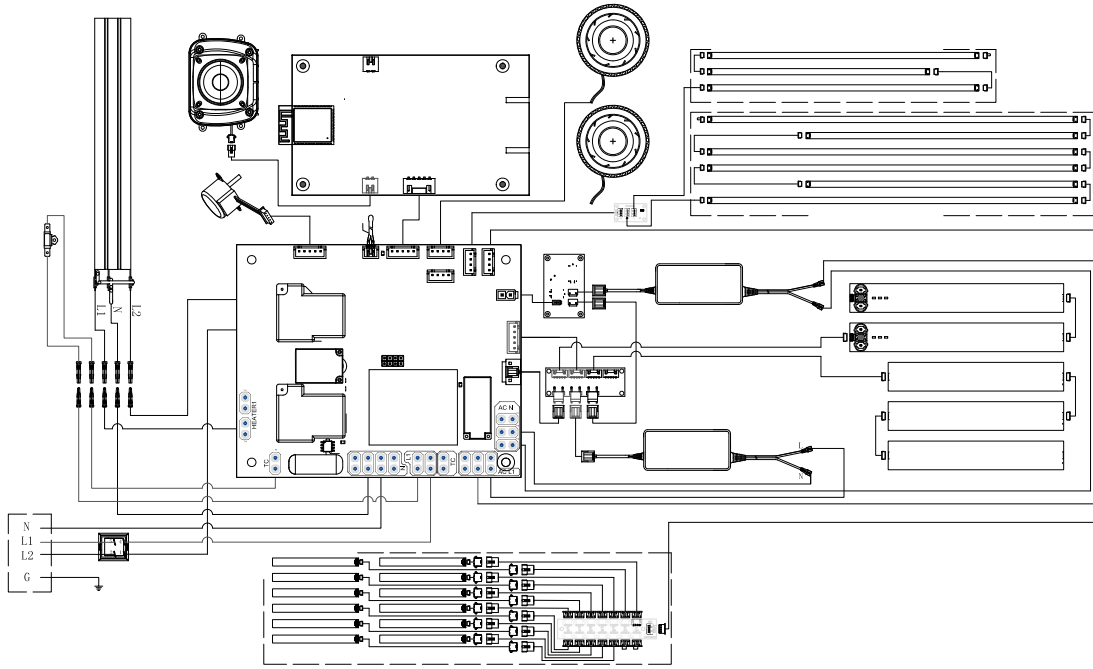

ULT100-AM

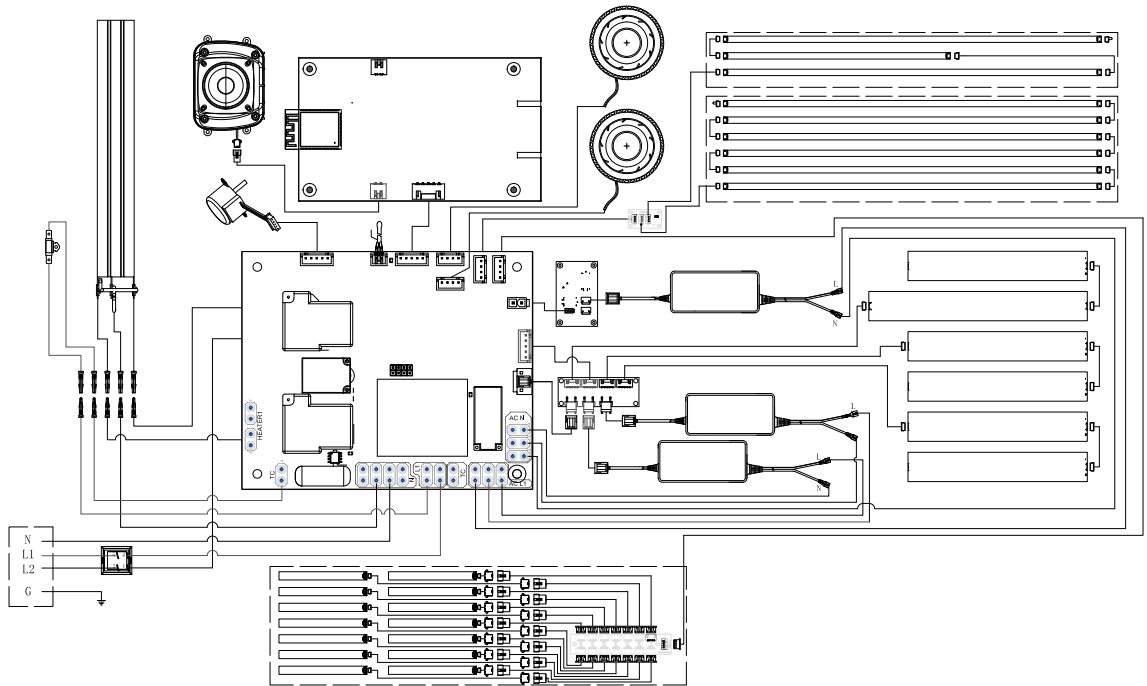

Warranty

IGNITE ULTRA™ 5-YEAR LIMITED WARRANTY

Section 1 Products to which this Limited Warranty Applies

This Limited Warranty applies to your newly purchased Dimplex electric fireplace with model numbers ULT50-AM, ULT60-AM, ULT74-AM, ULT88-AM, and ULT100-AM.

This Limited Warranty applies only to purchases made in any province of Canada except for Yukon Territory, Nunavut, or Northwest Territories or in any of the 50 States of the USA and the District of Columbia except for Hawaii and Alaska. This Limited Warranty applies to the original purchaser of the product only and is not transferable.

Section 2 Products excluded from this Limited Warranty

Products purchased in Yukon Territory, Nunavut, Northwest Territories, Hawaii, or Alaska are not covered by this Limited Warranty. Products purchased in these States, Provinces, or Territories are sold AS IS without Warranty or condition of any kind including, without limitation, any implied warranties or conditions of merchantability or fitness for a particular purpose. The entire risk of as to the quality and performance of the products is with the purchaser. In the event of a defect, the purchaser assumes the entire cost of all necessary servicing or repair.

Section 3 What this Limited Warranty covers and for How Long

Dimplex products ULT50-AM, ULT60-AM, ULT74-AM, ULT88-AM, and ULT100-AM, excluding trims and accessory packages are covered by this Limited Warranty, have been tested and inspected prior to shipment and, subject to the provisions of this Warranty, Glen Dimplex Americas Ltd. (herein called Glen Dimplex Americas) warrants such products to be free from defects in material and workmanship for a period of 5 years from the date of the first purchase of such products. The 5-year Limited Warranty entitles the purchaser to On-site or In-home Warranty Services. Accordingly, Glen Dimplex Americas will be responsible for all labor and transportation associated with repairing or replacing the product or part. Exceptions to this are outlined in Section 5. Some jurisdictions do not allow limitations on how long an implied Warranty lasts, so the above limitation may not apply to the purchaser.

Section 4 What this Limited Warranty Does Not Cover

This Limited Warranty does not apply to products that have been repaired (except by Glen Dimplex Americas or its authorized service representatives) or otherwise altered. This Limited Warranty does further not apply to defects resulting from misuse, abuse, accident, neglect, incorrect installation, improper maintenance or handling, or operation with an incorrect power source.

Section 5 How to notify us of a Warranty Concern

Defects must be brought to the attention of Dimplex Customer Service online at dimplex.com/en/contact_us or by telephone at 1-888-346-7539. Please have proof of purchase, catalogue/model and serial numbers available for representatives to assist. **Limited In-home Warranty Services require proof of purchase.

In the event a product or part covered by this Limited Warranty is proven to be defective in material or workmanship during (i) the 5-year Limited Warranty period for products outlined in Section 1, you have the following rights:

- Glen Dimplex Americas will in its sole discretion either repair or replace such defective product or part without charge. If Glen Dimplex Americas is unable to repair or replace such product or part, or if repair or replacement is not commercially practicable or cannot be timely made, Glen Dimplex Americas may, in lieu of repair or replacement, choose to refund the purchase price for such product or part.
- Limited Warranty service will be performed solely by dealers or service agents of Glen Dimplex Americas authorized to provide Limited Warranty services.
- This 5-year Limited Warranty entitles the purchaser to On-site or In-home Warranty services. Accordingly, Glen Dimplex Americas will be responsible for all labor and transportation associated with repairing or replacing the product or part except as follows: (i) charges which may be levied for travel costs incurred to travel to the purchaser's site where the product is located if the purchaser's site is beyond 30 miles (48 km) from the closest service depot of Glen Dimplex Americas dealer or service agent; and (ii) the purchaser is solely responsible for providing clear access to all serviceable parts of the product.
- Glen Dimplex Americas will not be responsible for, and this Limited Warranty shall not include, any expense incurred for installation or removal of the surrounds (mantels) or trims or any part thereof (or any replacement product or part) including, without limitation, all shipping costs and transportation costs to and from the authorized dealer's or service agent's place of business and all labor costs. Such costs shall be the purchaser's sole responsibility.

Section 6 When Glen Dimplex Americas and its Dealers and Service Agents are not Liable

IN NO EVENT WILL GLEN DIMPLEX AMERICAS, OR ITS DIRECTORS, OFFICERS, OR AGENTS, BE LIABLE TO THE PURCHASER OR ANY THIRD PARTY. WHETHER IN CONTRACT, IN TORT, OR ON ANY OTHER BASIS, FOR ANY INDIRECT, SPECIAL, PUNITIVE, EXEMPLARY, CONSEQUENTIAL, OR INCIDENTAL LOSS, COST, OR DAMAGE ARISING OUT OF OR IN CONNECTION WITH THE SALE, MAINTENANCE, USE, OR INABILITY TO USE THE PRODUCT, EVEN IF GLEN DIMPLEX AMERICAS OR ITS DIRECTORS, OFFICERS, OR AGENTS HAVE BEEN ADVISED OF THE POSSIBILITY OF SUCH LOSSES, COSTS OR DAMAGES, OR IF SUCH LOSSES, COSTS, OR DAMAGES ARE FORESEEABLE. IN NO EVENT WILL GLEN DIMPLEX AMERICAS, OR ITS OFFICERS, DIRECTORS, OR AGENTS BE LIABLE FOR ANY DIRECT LOSSES, COSTS, OR DAMAGES THAT EXCEED THE PURCHASE PRICE OF THE PRODUCT. SOME JURISDICTIONS DO NOT ALLOW THE EXCLUSION OR LIMITATION OF INCIDENTAL OR CONSEQUENTIAL DAMAGES, SO THE ABOVE LIMITATION OR EXCLUSION MAY NOT APPLY TO THE PURCHASER.

How State and Provincial law(s) apply

This Limited Warranty gives you specific legal rights, and you may also have other rights which vary from jurisdiction to jurisdiction. The provisions of the United Nations Convention on Contracts for the Sale of Goods shall not apply to this Limited Warranty or the sale of products covered by this Limited Warranty.



Welcome to Flame Connect

Control your electric fireplaces,
from the palm of your hand.



Connect your electric fireplaces

Add as many fireplaces as you like
to the Flame Connect App.



Personalize your product

Change modes and settings on
your fireplace to suit your mood.



Secure your device

Take ownership of a product to prevent
unauthorized access.



NEW! Flame Connect app

Download the Flame Connect app on your mobile device and create an account. With the app you can add an extra level of personalization, such as saving customized mood settings.

For additional information, visit www.flame-connect.com

Available in the App Store and Google Play



1-888-346-7539 | www.dimplex.com

In keeping with our policy of continuous
product improvement, we reserve the
right to make changes without notice.

© 2024 Glen Dimplex Americas